

Model RBAM-20L-240-AU42C

INSTANT-FLOW[®] MICRO: 20Amp 42°C Preset

APPLICATION: Commercial, industrial, public amenities, kitchen/bar sinks, hand washing stations.

Product Features

- Single phase
- Microprocessor temp & energy regulator
- Bare wire technology
- Continuous flow hot water
- Hot water in as little as 4 seconds¹
- Compact: 16cm x 26cm x 7cm
- 99% energy efficient
- Prevents scalding
- Prevents germs
- Watermark to AS3498-2009
- Australia & NZ Electrical approval (NSW Fair Trading #25588)
- Made in the USA
- **No** tempering valve required²



Description

The Chronomite Instant-Flow Micro - 42°C model is manufactured to provide reliable point-of-use hot water at up to a maximum of 42°C with a minimum pressure of 200kpa. The **microprocessor** adjusts the heater's power for variations in flow rates, inlet water temperature and pressure to assure the selected factory preset water temperature¹. There is no pressure and temperature relief valve required, saving time and money on installation.

¹When installed & sized correctly

²Certain applications may require additional protection. Please refer to AS/NZS 3500.4

Nominal Maximum Temperature Rise (ΔT)

Model	Temp Rise @ 2LPM	Temp Rise @ 3LPM	Temp Rise @ 4LPM	Temp Rise @ 5LPM	Temp Rise @ 6LPM	Temp Rise @ 7LPM
RBAM-20L-240-AU42C	34°C	23°C	17°C	14°C	12°C	10°C

Technical Information

Instant-Flow® Micro - 42°C

Dimensions:	158mm (H) x 259mm (W) x 70mm (D)
Weight:	2.27 kg
Materials:	ABS housing, Ryton waterways, nichrome parts
Housing Color:	White
Switch on Flow rate:	1.5 LPM
Pressure	200 - 600 kPa
Min. Water Resistivity	1100 Ohm.cm
Power	4800 Watts
Voltage	240 Volts
Breaker Size	20 Amps

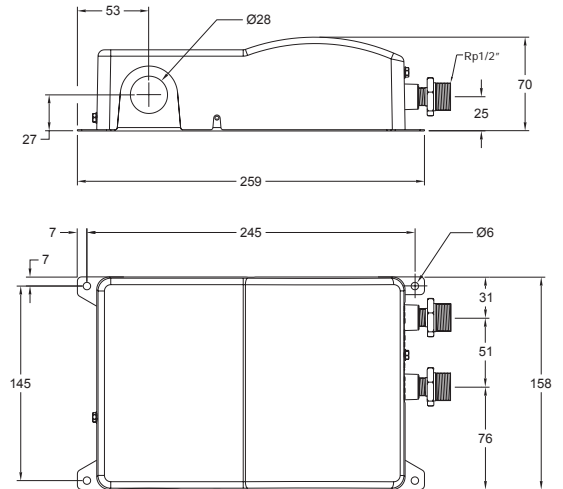

General Notes

- The microprocessor adjusts the heater's power for variations in flow rates, inlet water temperature and pressure to assure the selected factory preset water temperature.
- Instant-Flow Micro is ideal for sanitary tapware with the 42°C factory preset temperature; **no** mixing valve required.
- Microprocessor limits temperature increase according to the preselected temperature, in this case 42°C.
- Installation must comply with AS/NZS 3500.4, and AS3000, and be installed by a qualified personel.

Typical Installation Diagram

1. Chronomite Instant-Flow Micro
2. Isolation Switch
3. Electrical supply conduit
4. Electrical supply cable
5. 1/2" mini-cock and check valve
6. Fittings (Supplied) Rp1/2"
7. 1/2" x 8 mm Dia. flexible braided stainless steel connectors (By others)

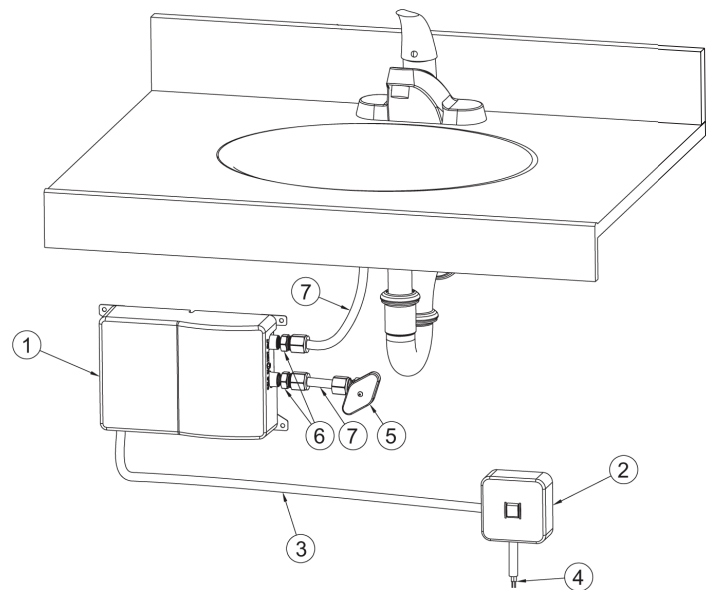

Heater to be installed below the level of all hot water outlets serviced by the heater.